



lninox

LINHA PET SHOP



# LINHA PET SHOP

GRADE PARA CANIL/GATIL - 50x40cm

Fabricamos sob medida. Solicite um orçamento - (67)99156-7656 / 3364-0688

Ininox

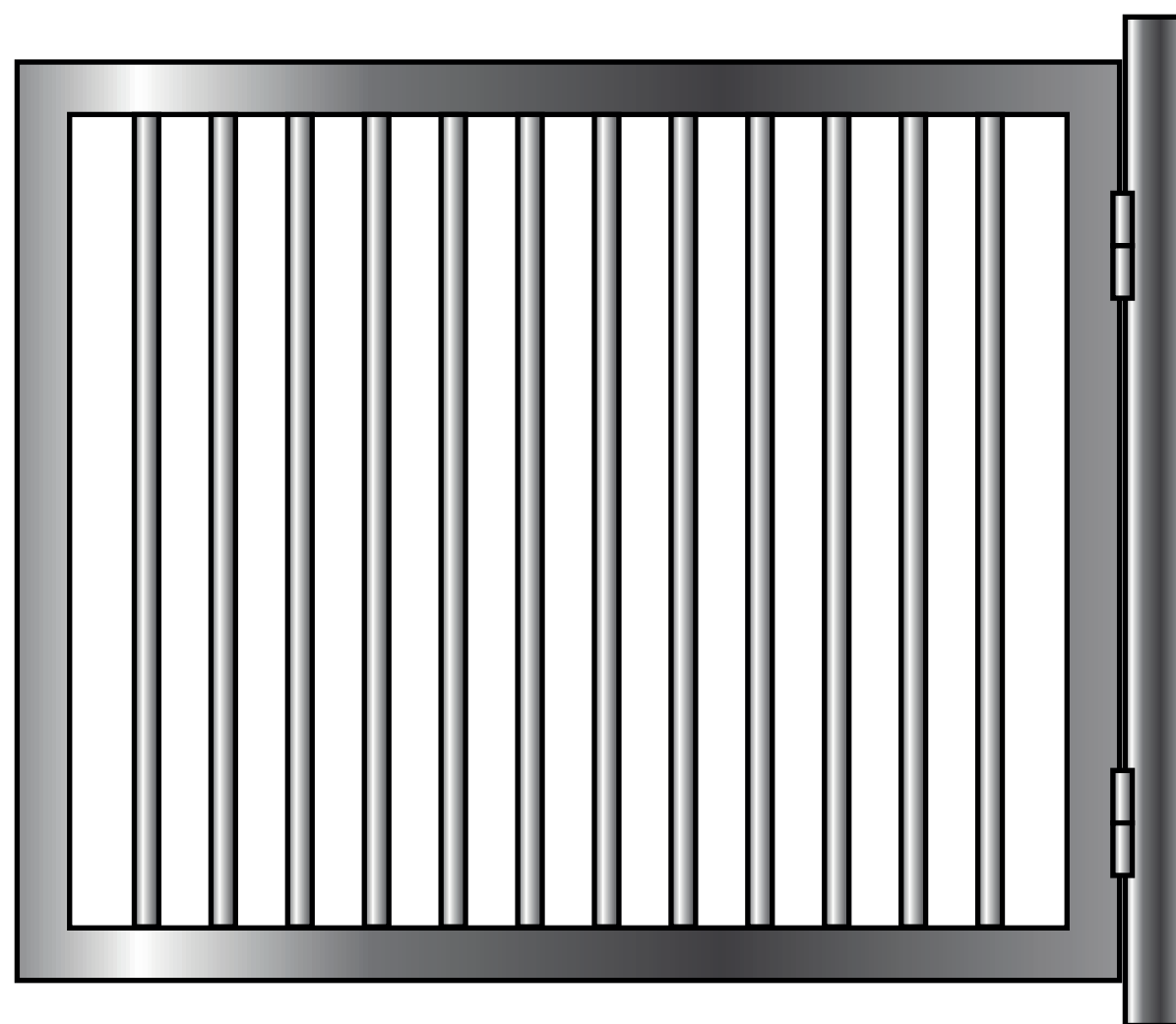

Visão Frente

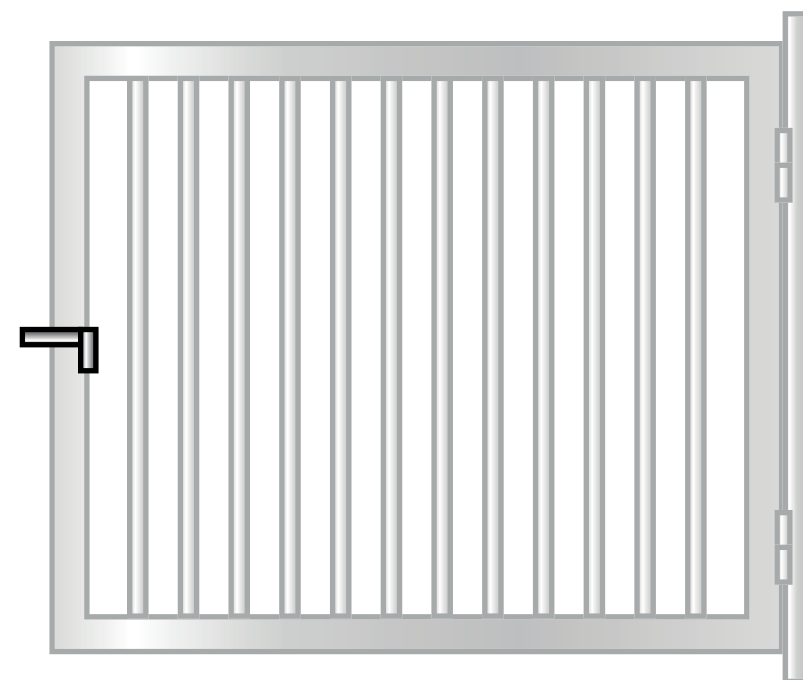

Fecho Laterar

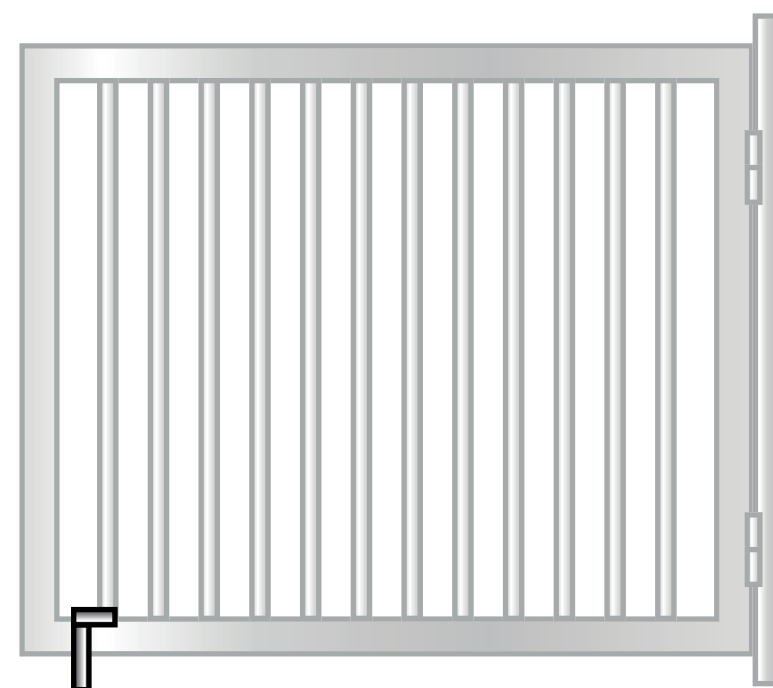

Fecho Inferior



# LINHA PET SHOP

GRADE PARA CANIL/GATIL - 50x40cm - Grade e Vidro

Fabricamos sob medida. Solicite um orçamento - (67)99156-7656 / 3364-0688

Ininox

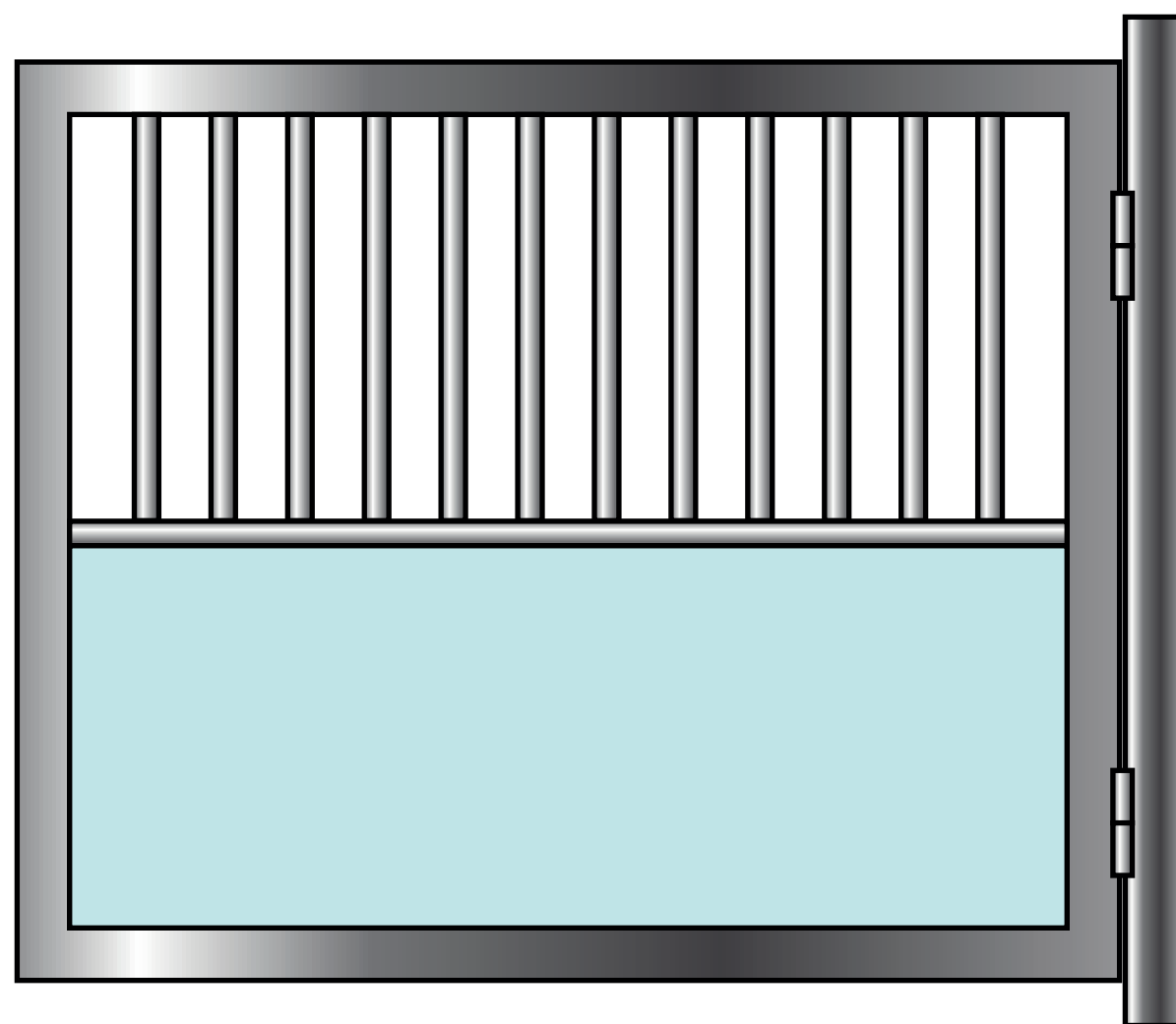

Visão Frente

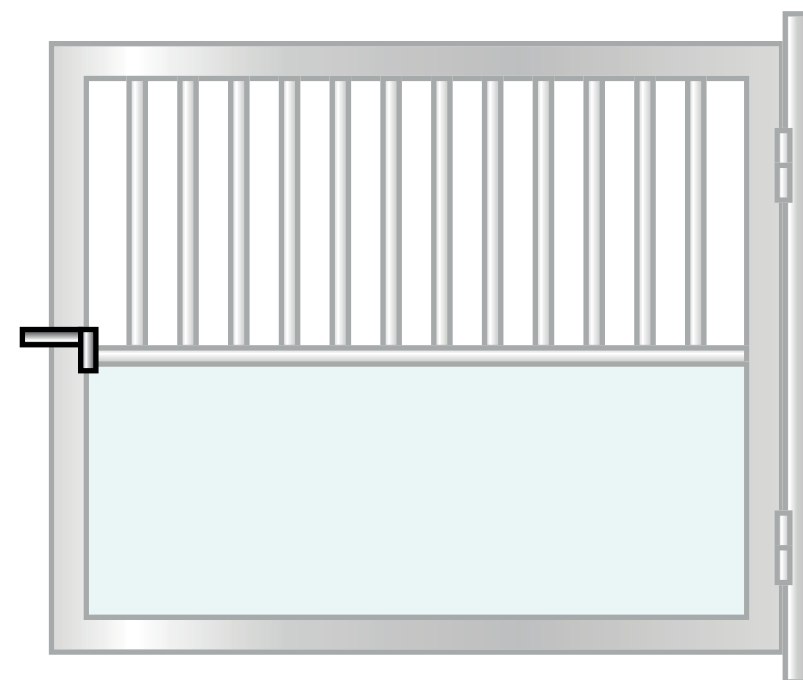

Fecho Laterar

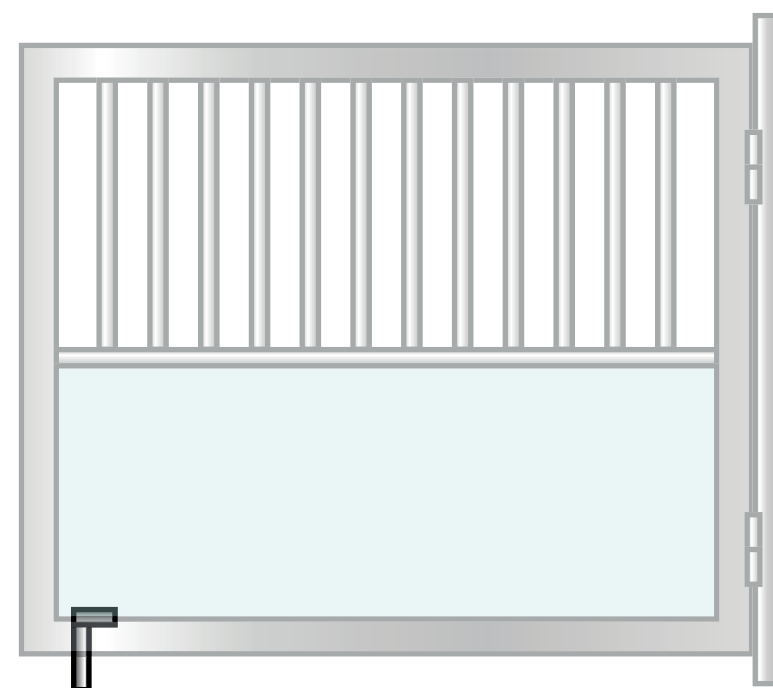

Fecho Inferior



# PET SHOP

MESA AUXILIAR EXAME - 0,8x0,5x0,9m - Reforçada com Trava

Fabricamos sob medida. Solicite um orçamento - (67)99156-7656 / 3364-0688

Ininox

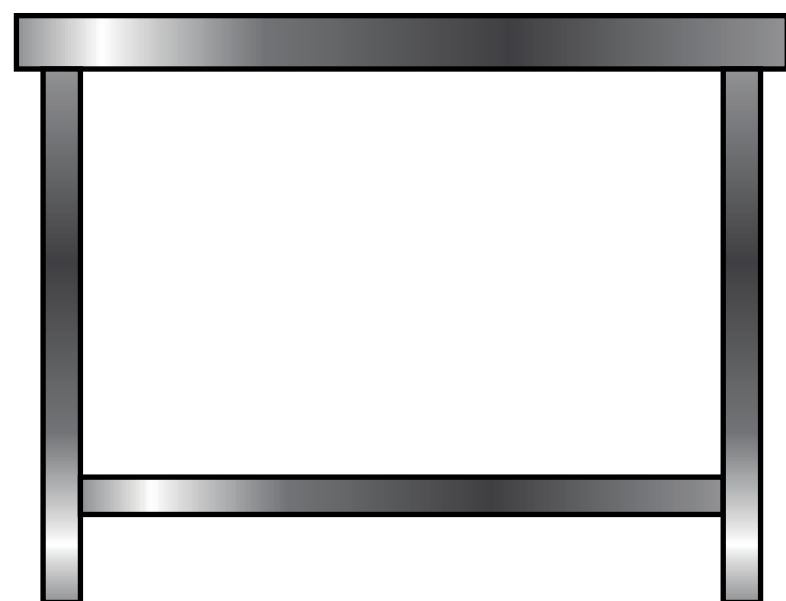

Visão Frente

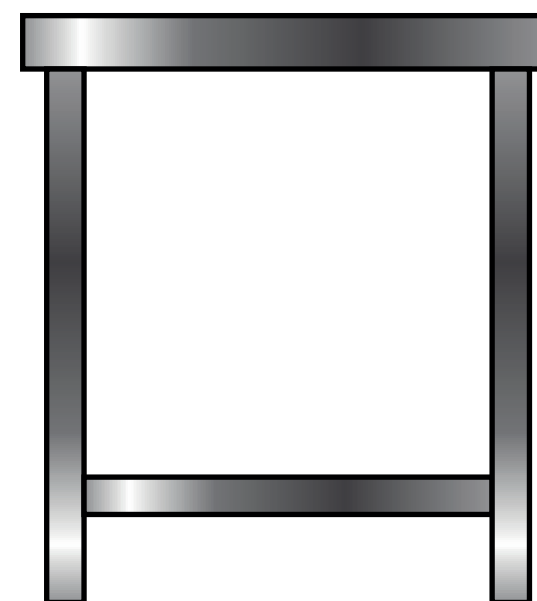

Visão Lateral

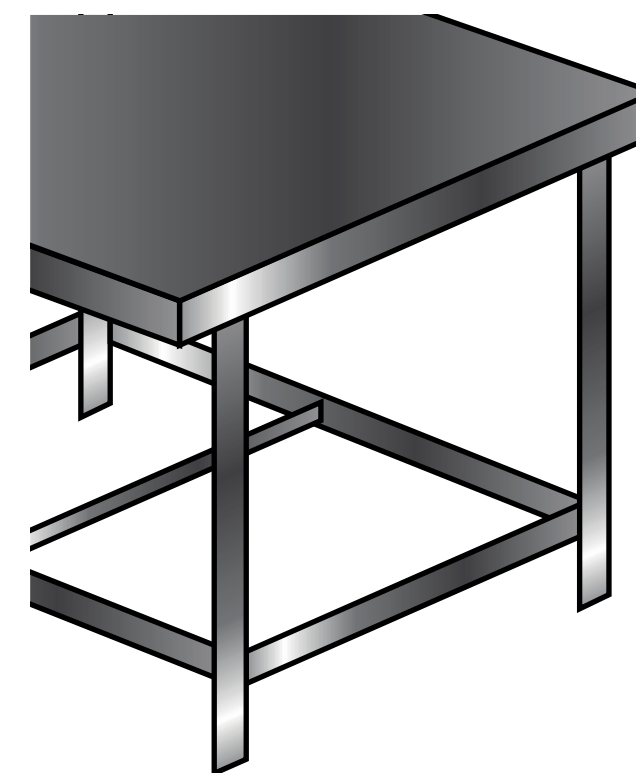

Detalhe da Trava



Ininox

# PET SHOP

MESA TOSA E VACINA - 1,5x0,7x0,9m - Reforçada com trava H

Fabricamos sob medida. Solicite um orçamento - (67)99156-7656 / 3364-0688



Visão Frente

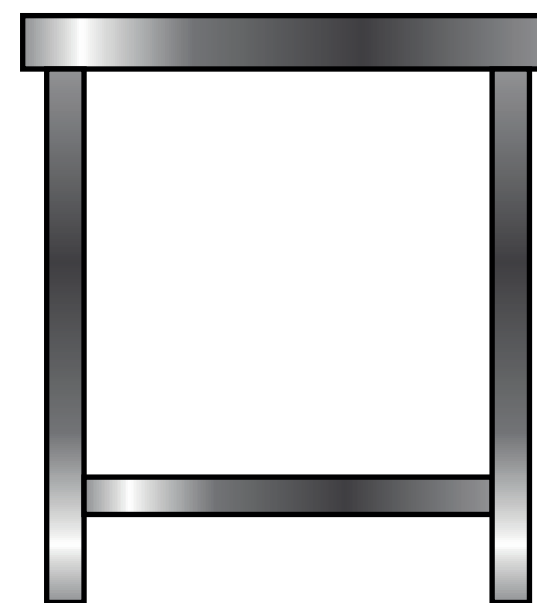

Visão Lateral

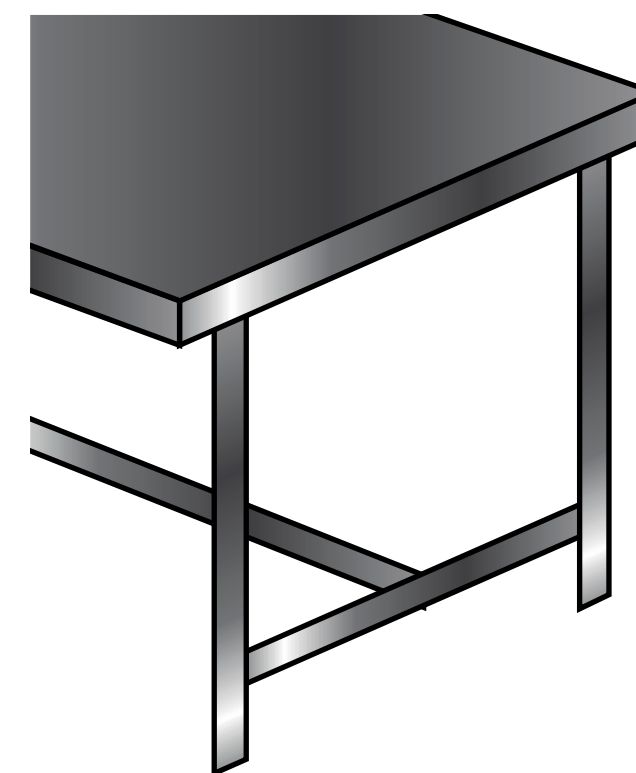

Detalhe da Trava



Ininox

# PET SHOP

MESA TOSA E VACINA - 1,5x0,7x0,9m - Reforçada com gradil

Fabricamos sob medida. Solicite um orçamento - (67)99156-7656 / 3364-0688



Visão Frente

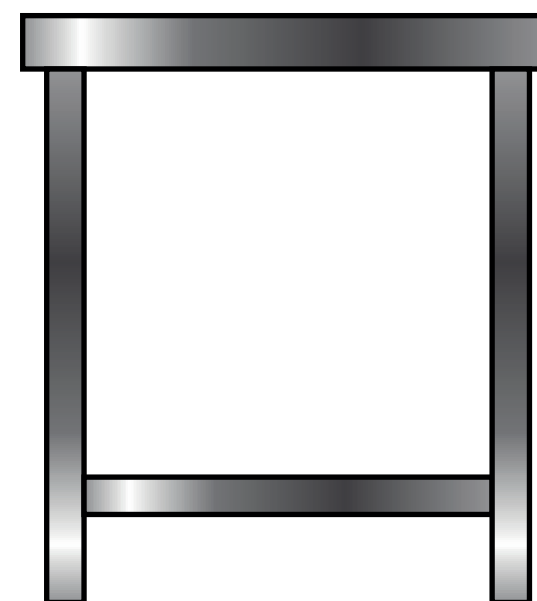

Visão Lateral

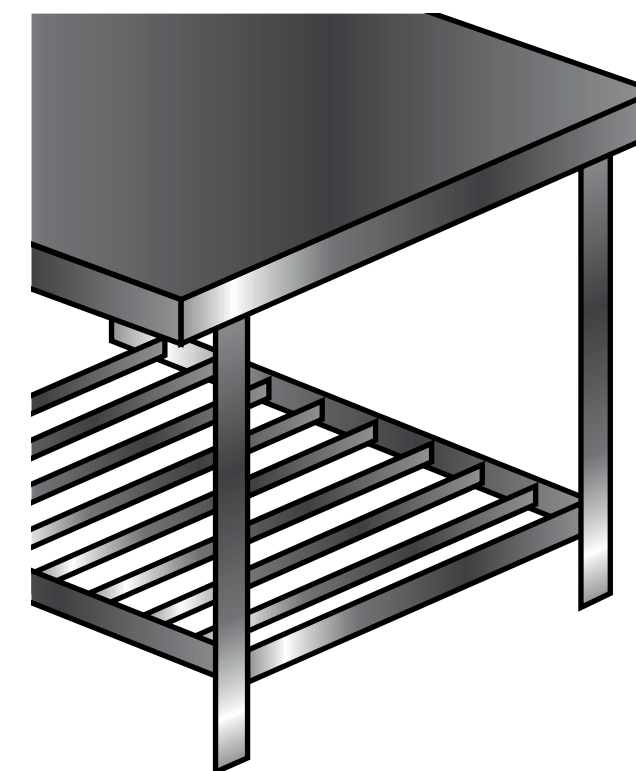

Detalhe do Gradil



Ininox

# PET SHOP

MESA CIRÚRGICA - 1,5x0,7x0,9m - Escoamento, Suporte para balde, pedestal e suporte horizontal  
Fabricamos sob medida. Solicite um orçamento - (67)99156-7656 / 3364-0688

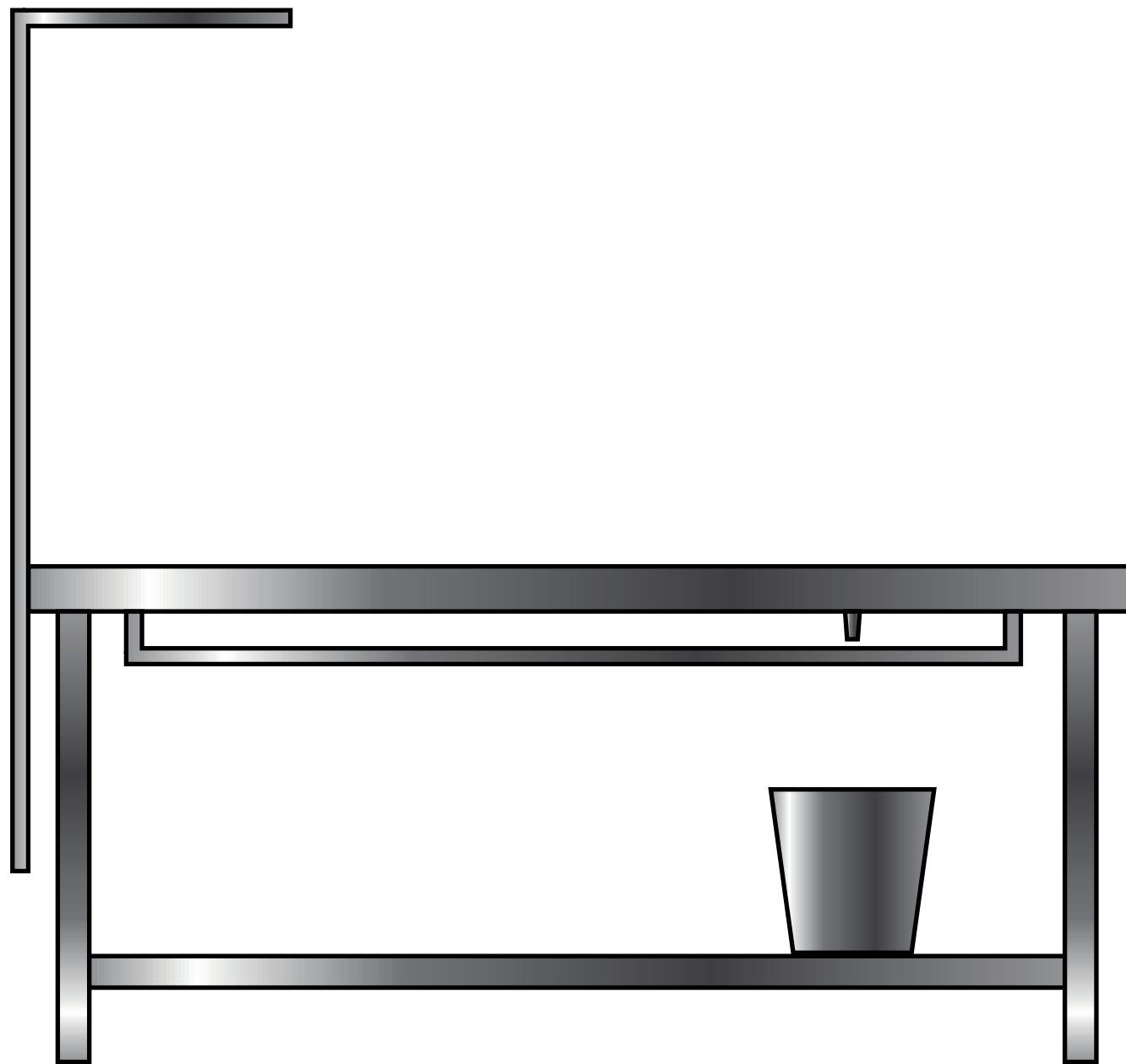

Visão Frente

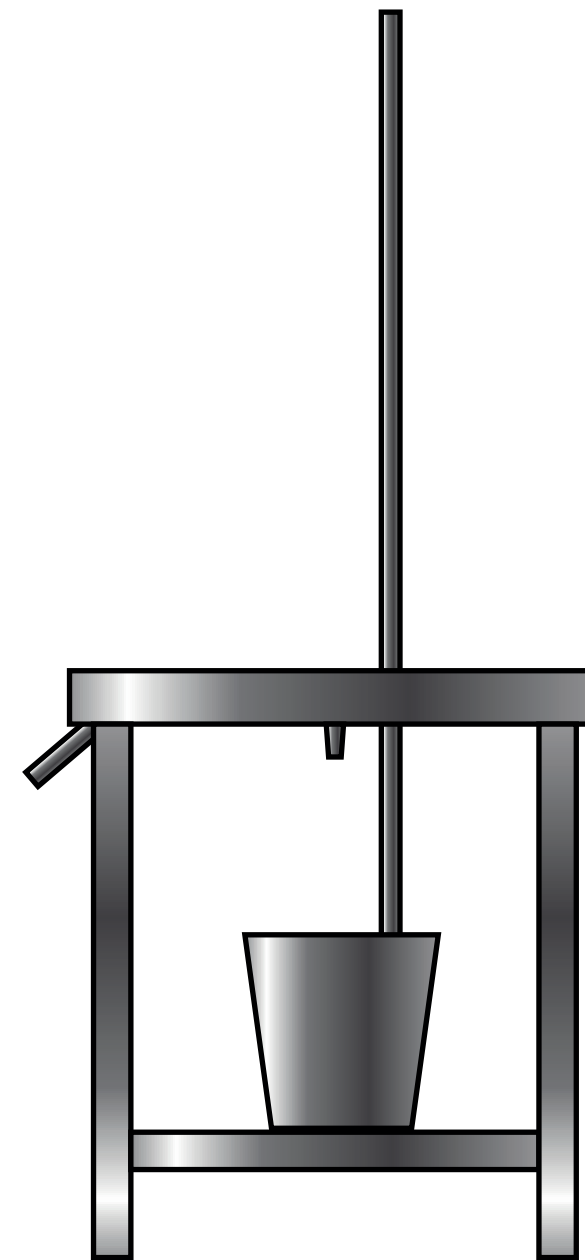

Visão Lateral

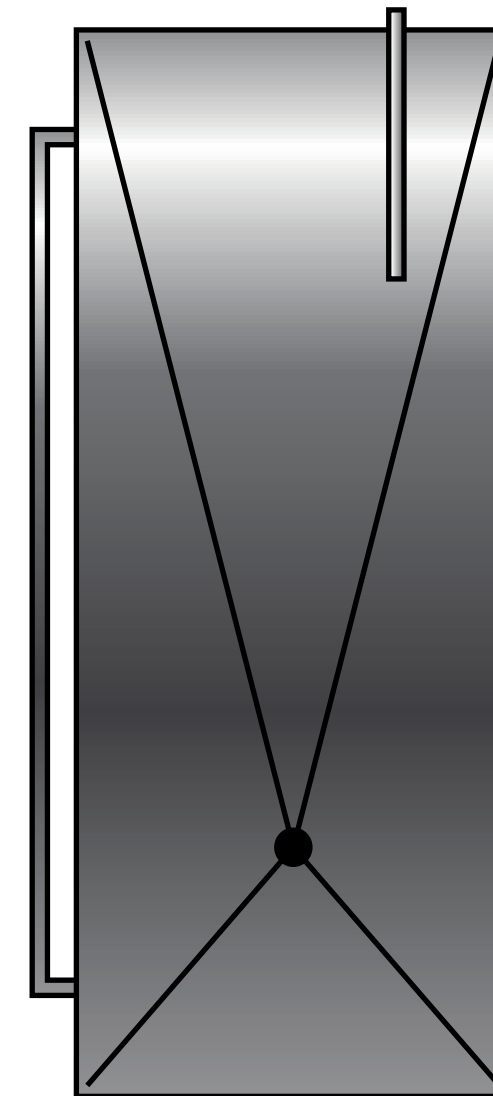

Visão Superior



Ininox

# PET SHOP

BANHEIRA - 1,2x0,7x0,9m - Projeto sugerido com porta, prendedor de coleira, ralo e torneira.  
Fabricamos sob medida. Solicite um orçamento - (67)99156-7656 / 3364-0688

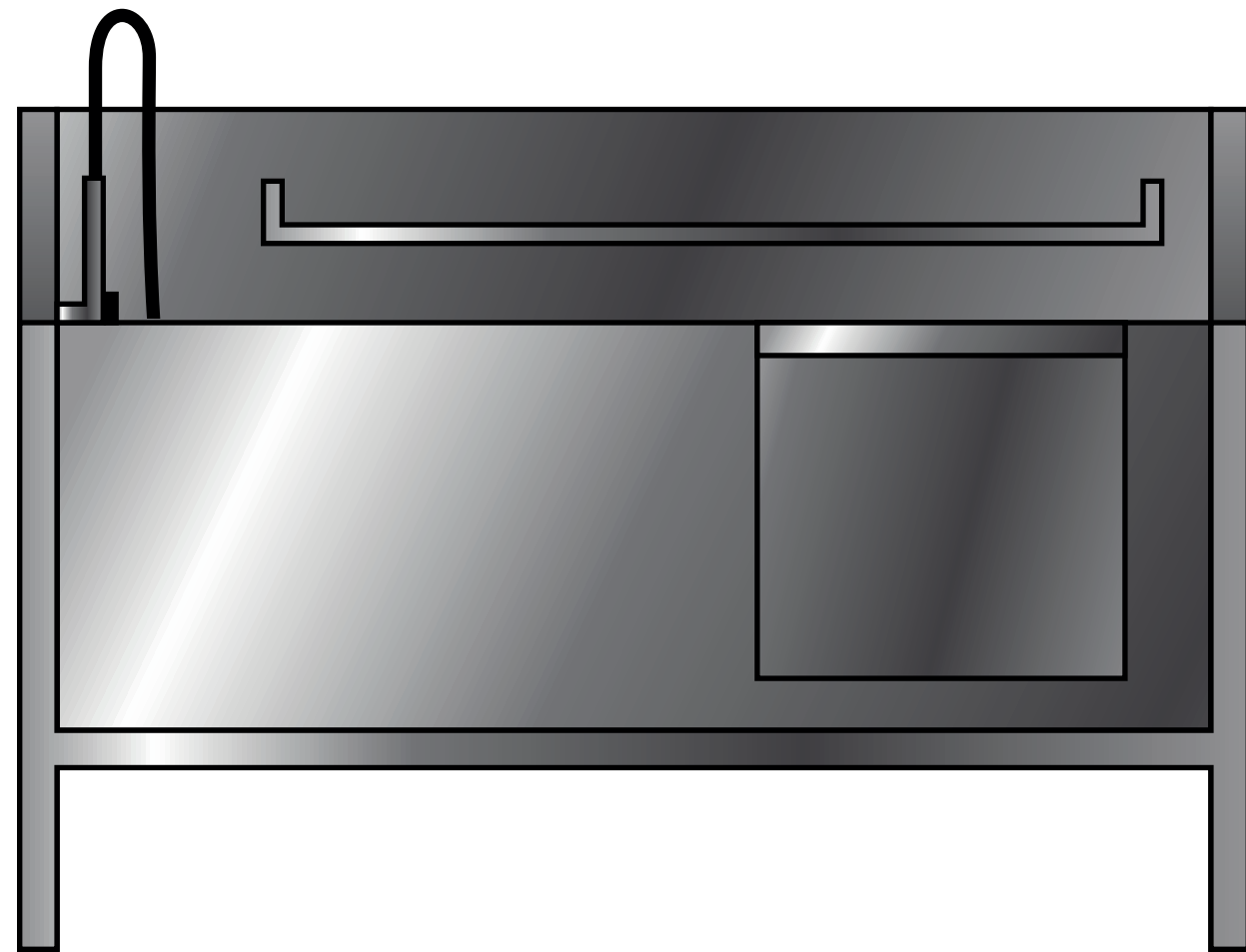

Visão Frente

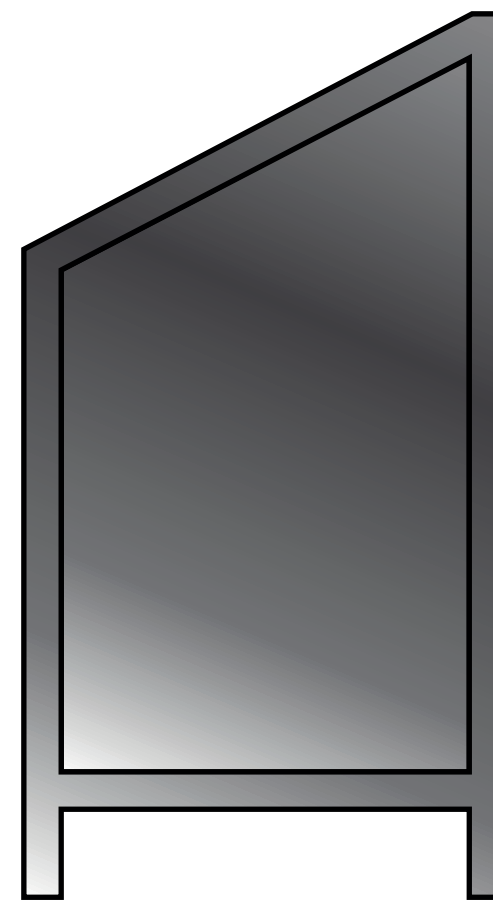

Visão Lateral

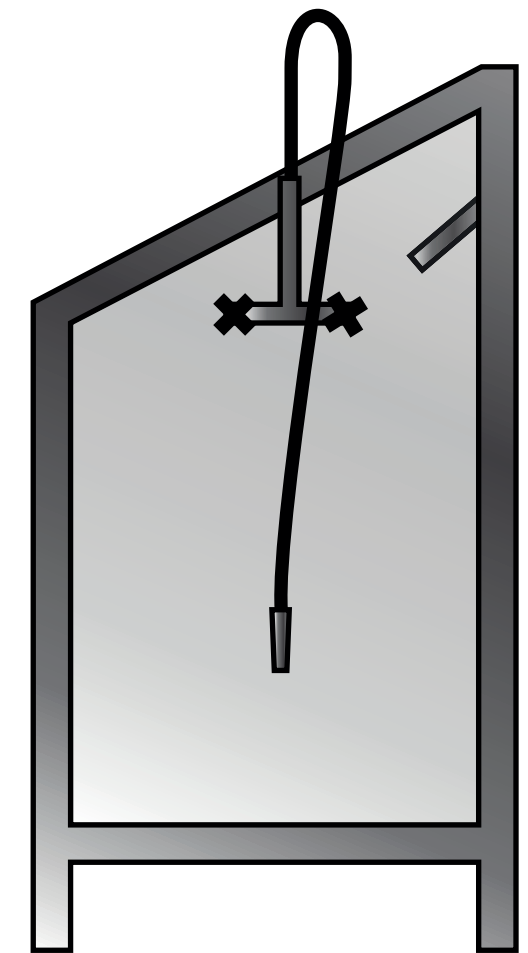

Corte Lateral e  
Acessórios





# PET SHOP

MESA INSTRUMENTAL CIRÚRGICA - 0,5x0,4x0,8m - Prateleira Inferior e Rodízios  
Fabricamos sob medida. Solicite um orçamento - (67)99156-7656 / 3364-0688

Ininox

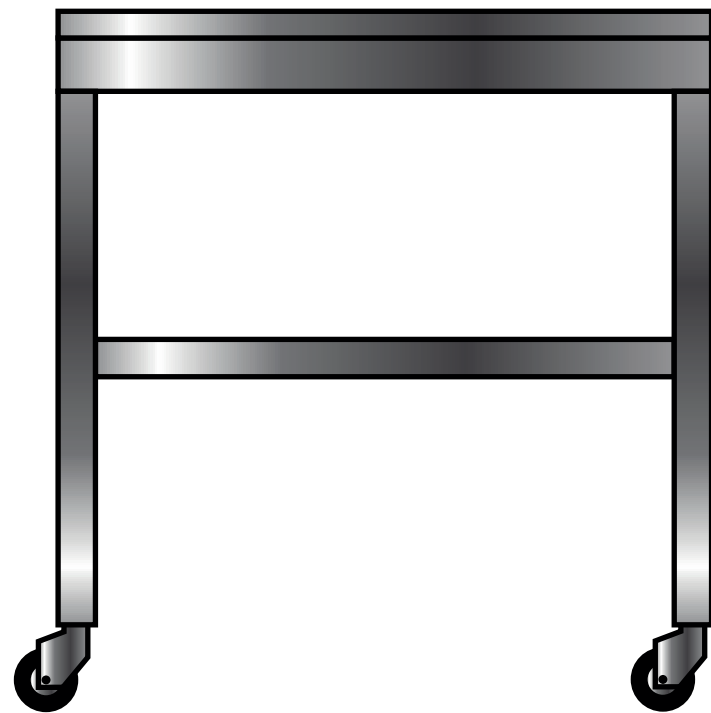

Visão Frente

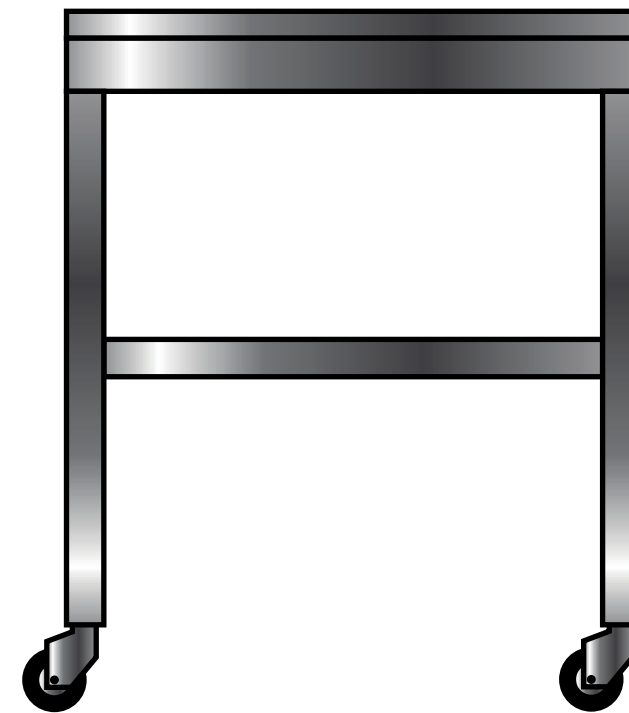

Visão Lateral

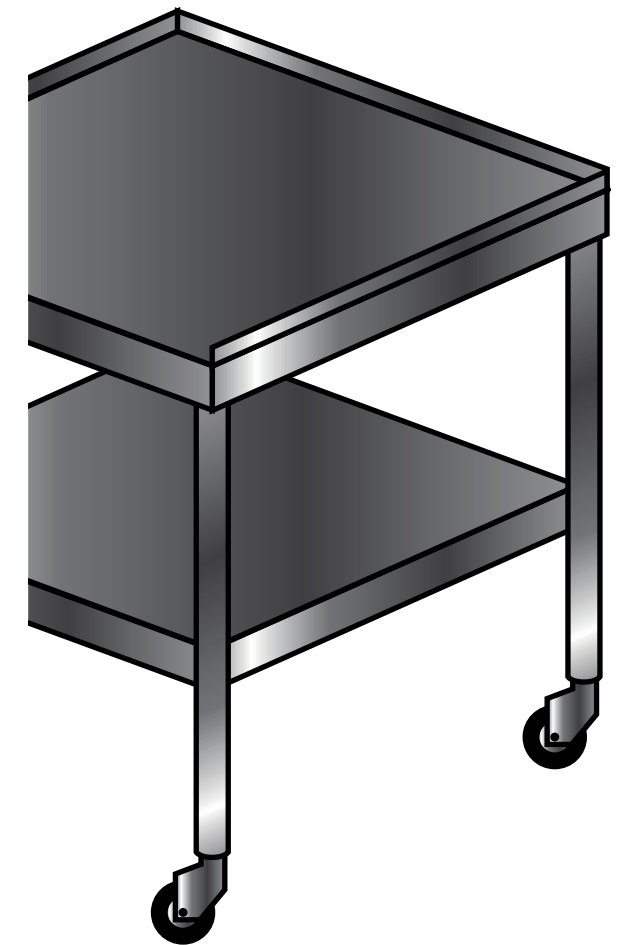

Perspectiva



Ininox

Fabricamos o seu projeto com aço inox e acabamentos de qualidade.  
Solicite um orçamento - (67)99156-7656 / 3364-0688  
[www.ininox.com.br](http://www.ininox.com.br)